



FEATURES

- $BV_{DSS}=600V, I_D=6A$
- $R_{DS(on)}:0.76\Omega(\text{Max})@V_{GS}=10V$
- Very low FOM $R_{DS(on)} \times Q_g$
- 100% avalanche tested
- RoHS compliant

APPLICATIONS

- Switch Mode Power Supply (SMPS)
- Uninterruptible Power Supply (UPS)
- Power Factor Correction (PFC)

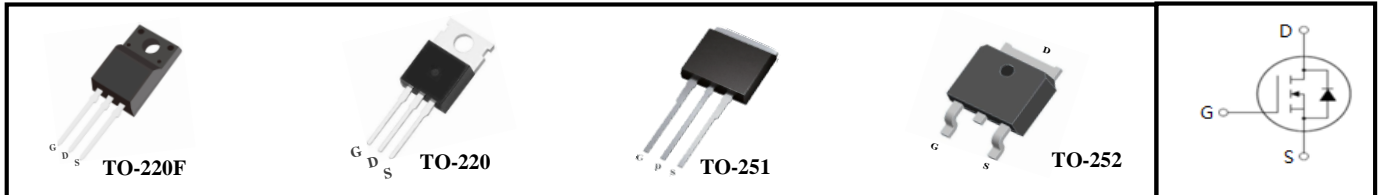

Device Marking and Package Information		
Ordering code	Package	Marking
MPSA60M760	TO-220F	MP60M760
MPSP60M760	TO-220	MP60M760
MPSU60M760	TO-251	MP60M760
MP60M760	TO-252	MP60M760

Absolute Maximum Ratings $T_C = 25^\circ\text{C}$, unless otherwise noted				
Parameter	Symbol	Value		Unit
		TO-220F	TO-220, TO-251, TO-252	
Drain-Source Voltage ($V_{GS} = 0V$)	V_{DSS}	600		V
Continuous Drain Current	I_D	6		A
Pulsed Drain Current (note1)	I_{DM}	12		A
Gate-Source Voltage	V_{GSS}	± 30		V
Single Pulse Avalanche Energy (note2)	E_{AS}	190		mJ
Avalanche Current (note1)	I_{AR}	2		A
Repetitive Avalanche Energy (note1)	E_{AR}	0.2		mJ
MOSFET dv/dt ruggedness, $V_{DS}=0\dots 400V$	dv/dt	50		V/ns
Reverse diode dv/dt, $V_{DS}=0\dots 400V, I_{SD}\leq I_D$	dv/dt	50		V/ns
Power Dissipation ($T_C = 25^\circ\text{C}$)	P_D	25	37	W
Operating Junction and Storage Temperature Range	T_J, T_{stg}	-55~+150		$^\circ\text{C}$

Thermal Resistance				
Parameter	Symbol	Value		Unit
		TO-220F	TO-220, TO-251, TO-252	
Thermal Resistance, Junction-to-Case	R_{thJC}	5	3.4	K/W
Thermal Resistance, Junction-to-Ambient	R_{thJA}	80	62	



芯基科技

MPSA60M760, MPSP60M760, MPSU60M760, MPST60M760

Specifications $T_J = 25^\circ\text{C}$, unless otherwise noted						
Parameter	Symbol	Test Conditions	Value			Unit
			Min.	Typ.	Max.	
Static						
Drain-Source Breakdown Voltage	$V_{(BR)DSS}$	$V_{GS} = 0V, I_D = 250\mu A$	600	--	--	V
Zero Gate Voltage Drain Current	I_{DSS}	$V_{DS} = 600V, V_{GS} = 0V, T_J = 25^\circ\text{C}$	--	--	1	μA
		$V_{DS} = 600V, V_{GS} = 0V, T_J = 150^\circ\text{C}$	--	--	100	
Gate-Source Leakage	I_{GSS}	$V_{GS} = \pm 30V$	--	--	± 100	nA
Gate-Source Threshold Voltage	$V_{GS(th)}$	$V_{DS} = V_{GS}, I_D = 0.25mA$	2.5	--	4.5	V
Drain-Source On-Resistance (Note3)	$R_{DS(on)}$	$V_{GS} = 10V, I_D = 3A$	--	0.68	0.76	Ω
Gate Resistance	R_G	$f = 1.0MHz, \text{open drain}$	--	14	--	Ω
Dynamic						
Input Capacitance	C_{iss}	$V_{GS} = 0V, V_{DS} = 100V, f = 1.0MHz$	--	396	--	μF
Output Capacitance	C_{oss}		--	16	--	
Reverse Transfer Capacitance	C_{rss}		--	2.7	--	
Total Gate Charge	Q_g	$V_{DD} = 400V, I_D = 6A, V_{GS} = 10V$	--	10.4	--	nC
Gate-Source Charge	Q_{gs}		--	2	--	
Gate-Drain Charge	Q_{gd}		--	5	--	
Turn-on Delay Time	$t_{d(on)}$	$V_{DD} = 400V, I_D = 6A, V_{GS} = 10V, R_G = 25\Omega$	--	42	--	ns
Turn-on Rise Time	t_r		--	28	--	
Turn-off Delay Time	$t_{d(off)}$		--	97	--	
Turn-off Fall Time	t_f		--	20	--	
Drain-Source Body Diode Characteristics						
Continuous Body Diode Current	I_S	$T_C = 25^\circ\text{C}$	--	--	6	A
Pulsed Diode Forward Current	I_{SM}		--	--	12	
Body Diode Voltage	V_{SD}	$T_J = 25^\circ\text{C}, I_{SD} = 6A, V_{GS} = 0V$	--	0.9	1.2	V
Reverse Recovery Time	t_{rr}	$V_R = 400V, I_F = 6A, di_F/dt = 100A/\mu s$	--	320	--	ns
Reverse Recovery Charge	Q_{rr}		--	2.2	--	μC
Peak Reverse Recovery Current	I_{rrm}		--	15	--	A

Notes

1. Repetitive Rating: Pulse width limited by maximum junction temperature
2. $I_{AS} = 2A, V_{DD} = 50V, R_G = 25\Omega, \text{Starting } T_J = 25^\circ\text{C}$
3. Pulse Test: Pulse width $\leq 300\mu s, \text{Duty Cycle } \leq 1\%$

Typical Characteristics $T_J = 25^\circ\text{C}$, unless otherwise noted

Figure 1. Output Characteristics ($T_J = 25^\circ\text{C}$)

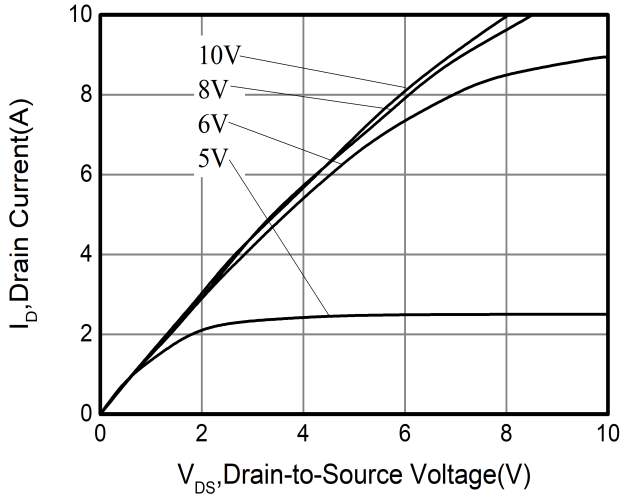

Figure 2. Transfer Characteristics

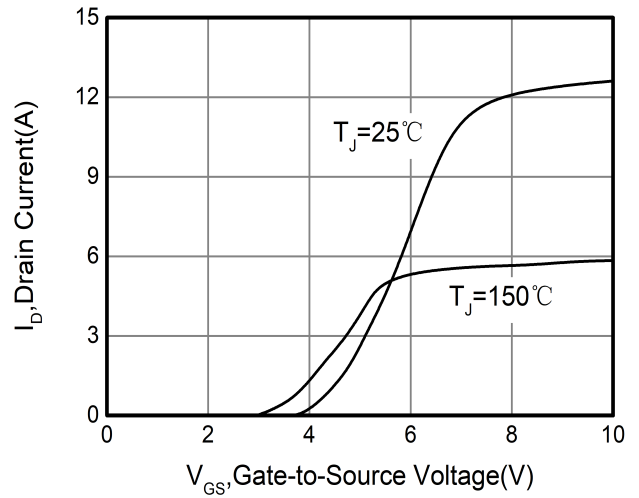

Figure 3. On-Resistance vs Drain Current

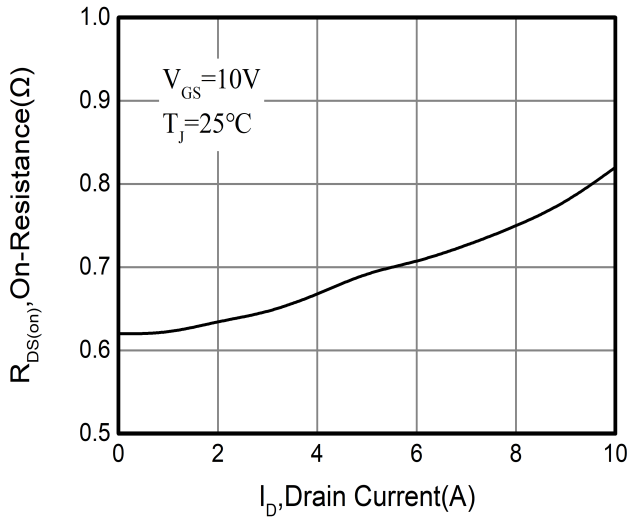

Figure 4. Capacitance

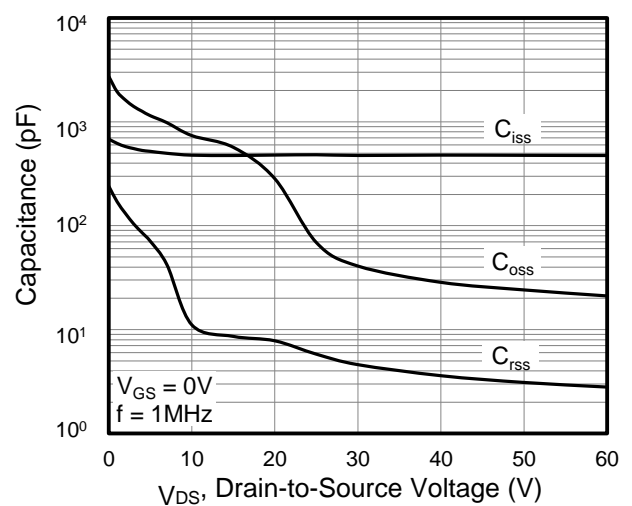

Figure 5. Gate Charge

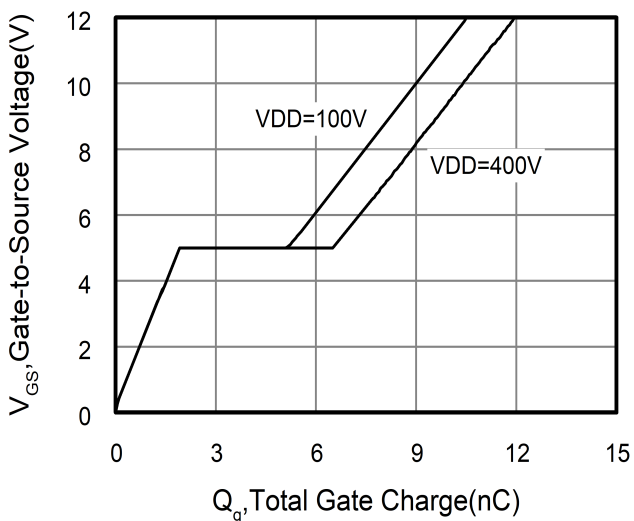
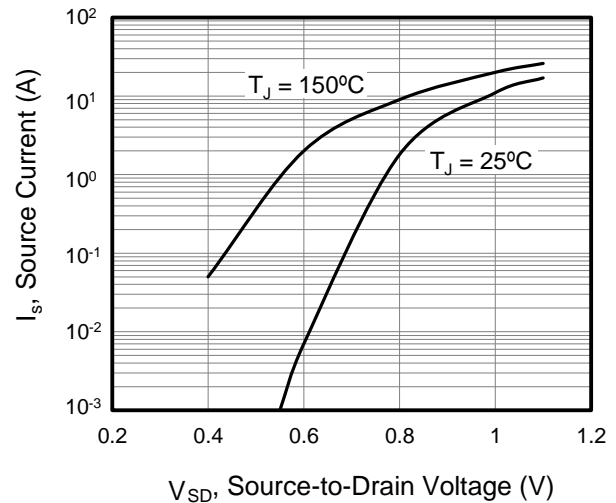

Figure 6. Body Diode Forward Voltage



Typical Characteristics $T_J = 25^\circ\text{C}$, unless otherwise noted

Figure 7. On-Resistance vs. Junction Temperature

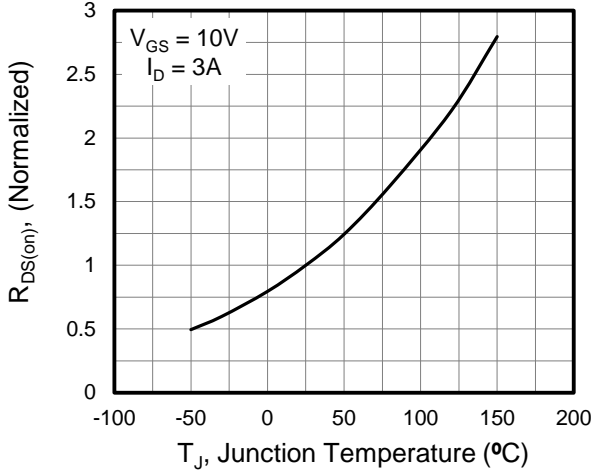

Figure 8. Threshold Voltage vs. Junction Temperature

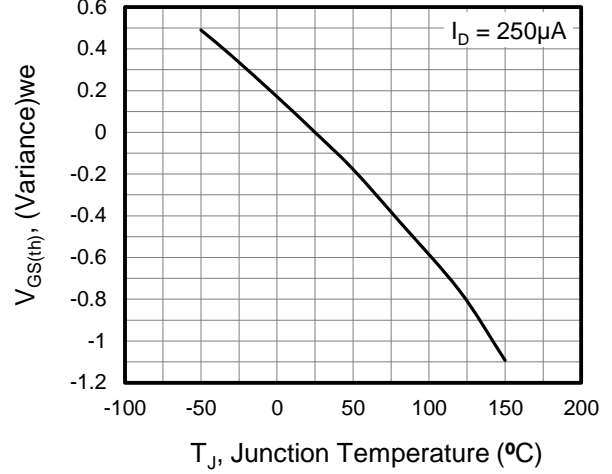

Figure 9. Transient Thermal Impedance TO-220, TO-251, TO-252

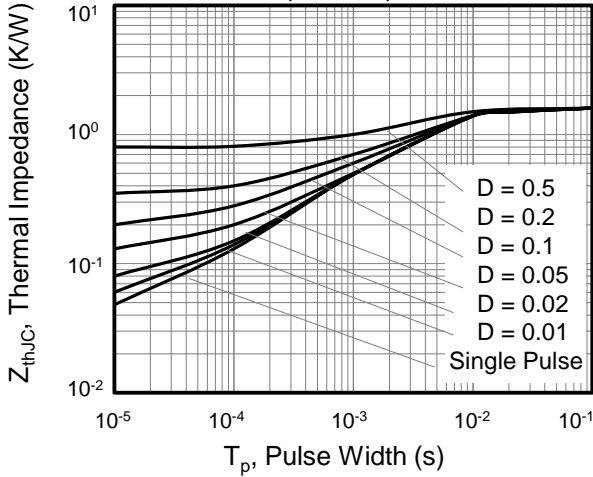

Figure 10. Transient Thermal Impedance TO-220F

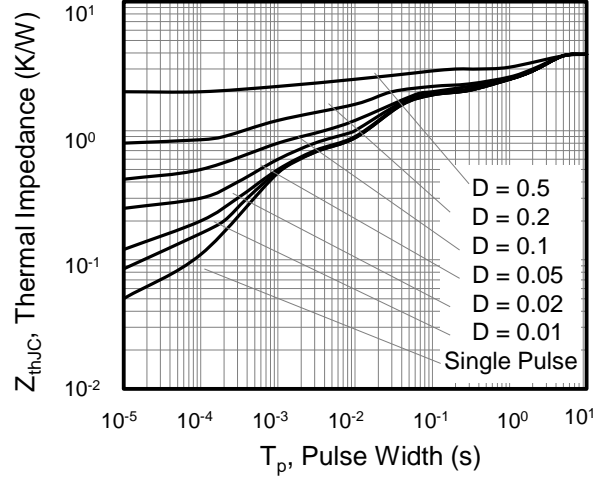

Figure A: Gate Charge Test Circuit and Waveform

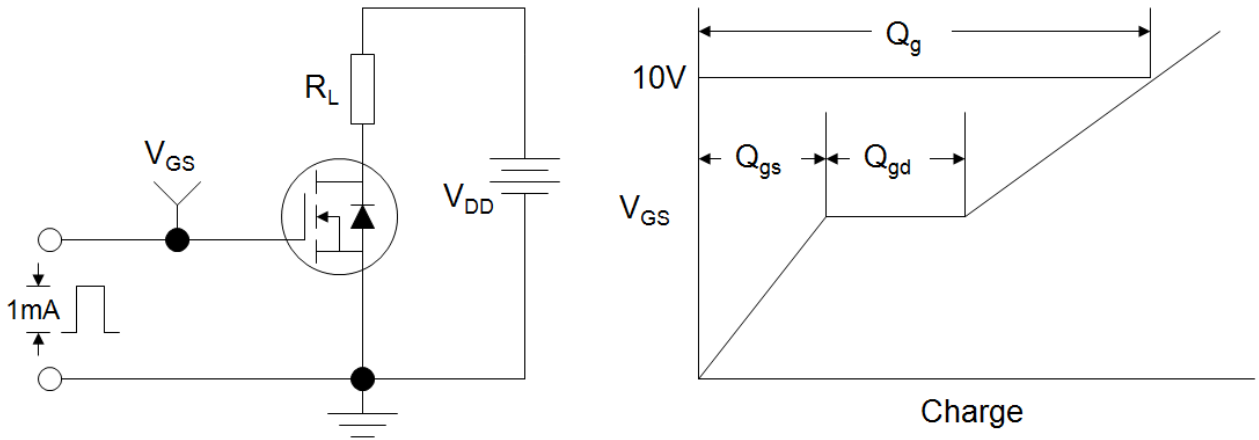

Figure B: Resistive Switching Test Circuit and Waveform

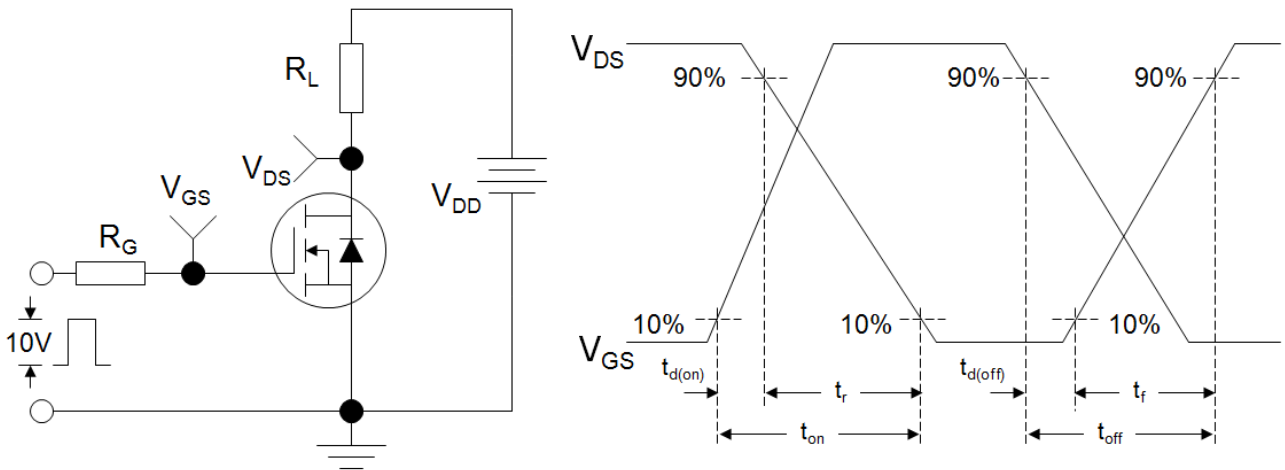
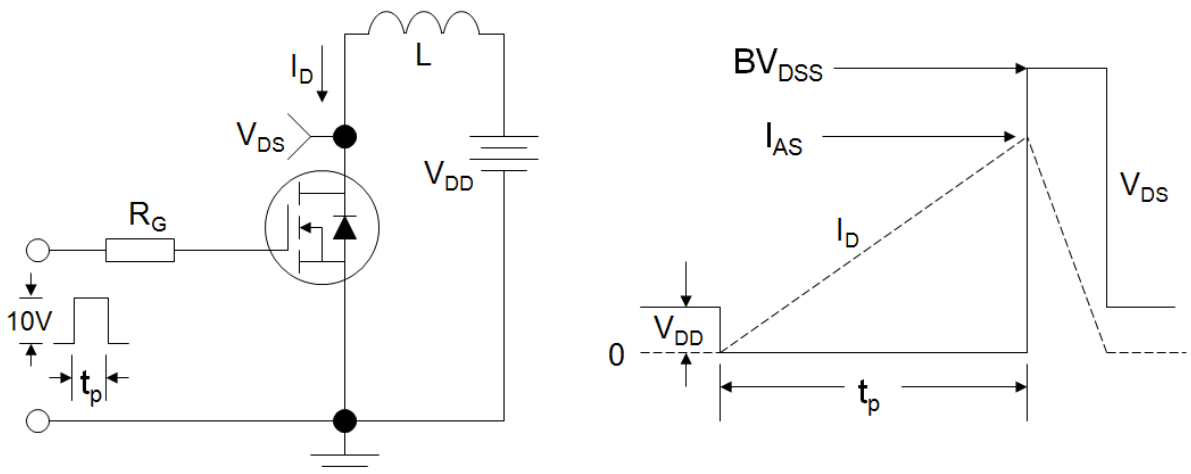
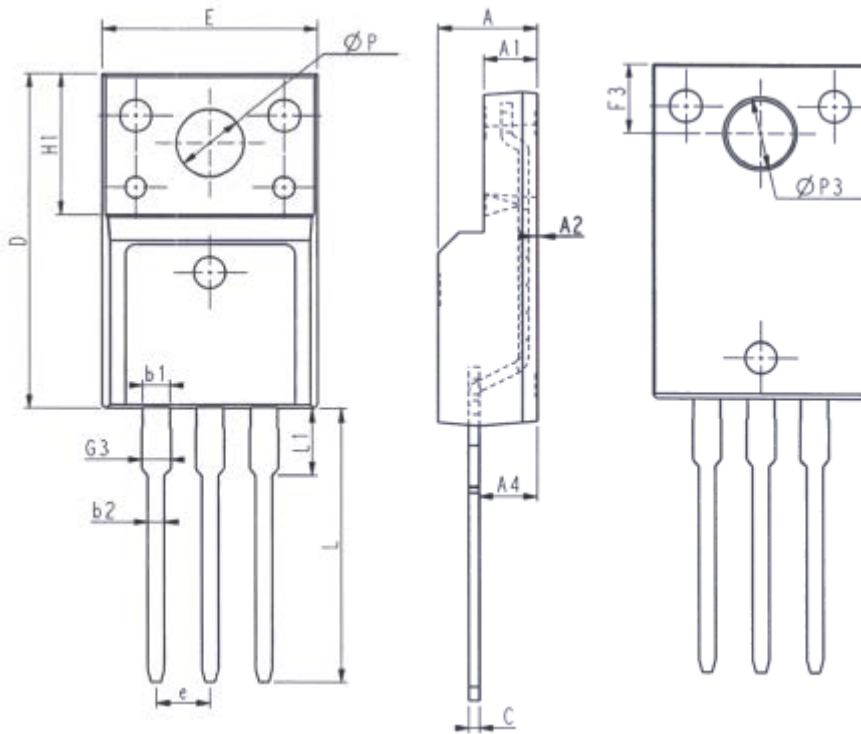

Figure C: Unclamped Inductive Switching Test Circuit and Waveform



TO-220F



Unit: mm			Unit: mm		
Symbol	Min.	Max.	Symbol	Min.	Max.
E	9.96	10.36	L	12.68	13.28
A	4.50	4.90	L1	2.93	3.13
A1	2.34	2.74	P	3.03	3.38
A2	0.30	0.60	P3	3.15	3.65
A4	2.56	2.96	F3	3.15	3.45
c	0.40	0.65	G3	1.25	1.55
D	15.57	16.17	b1	1.18	1.43
H1	6.70REF		b2	0.70	0.95
e	2.54BSC				

TO-220

TO-251

TO-252